

## TE613LED, 3-LIGHT TRIMLESS LED MULTIPLE RECESS

### PRODUCT DETAILS

No.	:	TE613LED-35-2-01
Product Color	:	BLACK
Length	:	12.1875"
Width	:	4"
Height	:	5"



### LIGHT SOURCE DETAILS

Light Source Type	:	INTEGRATED LED
Input Voltage	:	120V
Bulb Voltage	:	120V
Socket Type	:	LED
Total Wattage	:	45W
Total Lumen	:	3870lm
Kelvin	:	3500K
CRI	:	90
Dimmable	:	Yes

### Options Available

ITEM NO.	FINISH	SHADE
TE613LED-35-2-01	BLACK	
TE613LED-35-2-02	WHITE	

### TECHNICAL DETAILS

Driver	:	ES 16.8W Current Driver
Location	:	DRY
Approval	:	
Title 24	:	Yes
Beam Angle	:	20
Cut Hole Length	:	12.375"
Cut Hole Width	:	4.188"

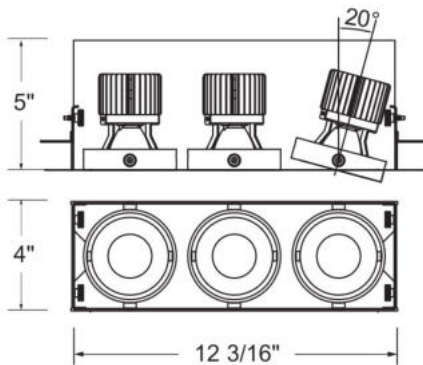

### PROJECT INFORMATION

 Job Name:       Date:       Type: 

 Comments: