

## TE222LED, 2-LIGHT TRIMLESS LED MULTIPLE RECESS

### PRODUCT DETAILS

No.	:	TE222LED-35-4-01
Product Color	:	BLACK
Length	:	12.25"
Width	:	6.25"
Height	:	7"



### LIGHT SOURCE DETAILS

Light Source Type	:	INTEGRATED LED
Input Voltage	:	120V
Bulb Voltage	:	120V
Socket Type	:	LED
Total Wattage	:	52W
Total Lumen	:	5000lm
Kelvin	:	3500K
CRI	:	90
Dimmable	:	Yes

### Options Available

ITEM NO.	FINISH	SHADE
TE222LED-35-4-01	BLACK	
TE222LED-35-4-02	WHITE	

### TECHNICAL DETAILS

Driver	:	Inventronics 35W Current Driver
Approval	:	
Title 24	:	Yes
Beam Angle	:	40
Cut Hole Length	:	12.5"
Cut Hole Width	:	6.5"

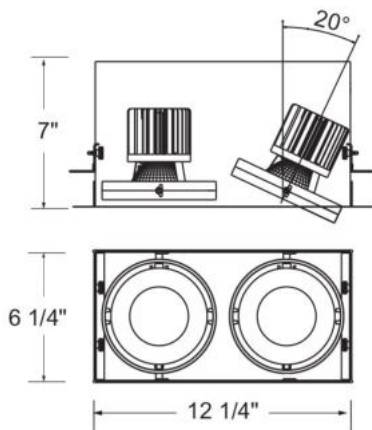

### PROJECT INFORMATION

 Job Name:       Date:       Type: 

 Comments: