

## TE132LED, 2-LIGHT LED MULTIPLE RECESS



### PRODUCT DETAILS

No.	:	TE132LED-40-2-01
Product Color	:	BLACK
Shade / Accent Colour	:	BLACK
Length	:	13.4375"
Width	:	7.75"
Height	:	7"
Weight	:	5lbs

### LIGHT SOURCE DETAILS

Light Source Type	:	INTEGRATED LED
Input Voltage	:	120V
Bulb Voltage	:	120V
Socket Type	:	LED
Total Wattage	:	52W
Total Lumen	:	5000lm
Kelvin	:	4000K
CRI	:	90
Dimmable	:	Yes

### Options Available

ITEM NO.	FINISH	SHADE
TE132LED-40-2-01	BLACK	BLACK
TE132LED-40-2-02	WHITE	BLACK
TE132LED-40-2-22	WHITE	WHITE

### TECHNICAL DETAILS

Driver	:	Inventronics 35W Driver
Location	:	DRY
Approval	:	
Title 24	:	Yes
Beam Angle	:	20
Cut Hole Length	:	12.5"
Cut Hole Width	:	6.75"

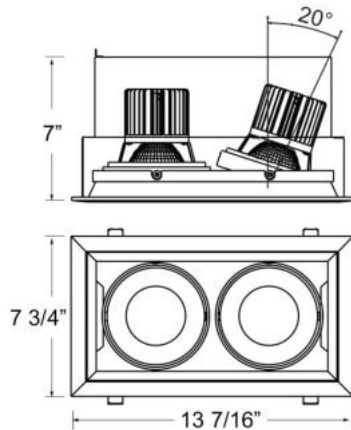

### PROJECT INFORMATION

Job Name:  Date:  Type:

Comments: