

INSTRUCTION MANUAL	MODE D'EMPLOI	MANUAL DE INSTRUCCIONES
31926-010 / 31931-014 / 31932-011 / 31933-018		
31934-015 / 31935-012 / 31936-019 / 31937-016		
31938-013 / 31939-010 / 31940-016 / 31941-013		
31942-010 / 31975-018 / 31943-017 / 31944-014		
31945-011 / 31946-018 / 31949-019 / 31950-015		
31973-014 / 31951-012 / 31952-019		

### Thank You

You've just purchased a lighting product designed and built to provide you

### Merci

Vous venez d'acheter un système d'éclairage conçu et fabriqué pour vous donner des années

### Gracias

Has comprado un producto de iluminación diseñado y fabricado para proporcionarte muchos años de



## SAVE THESE INSTRUCTIONS FOR FUTURE REFERENCE

Follow the assembly instructions by reading the numerical progression.

Use a qualified electrician for installation of this lighting fixture.

Before installing fixture, disconnect power by turning off the circuit breaker or by removing the fuse at the fuse box.

All electrical connections must be in accordance with local and National Electrical Code or Canadian Electrical Code standards.

Use CSA or UL listed wire connectors suitable for the gauge, type and number of conductors.

Attach junction box grounding wire (green or bare copper) and the bare copper wire from the fixture together. If junction box has no ground wire, attach the bare copper fixture wire to the green ground screw on the crossbar.

Estimated Assembly Time: 20 minutes

Tools Required For Assembly (not included): Flathead screwdriver, Phillips screwdriver, Pliers, Electrical tape and Wire cutters.

Helpful Tools (not included): Wire strippers, Ladder

## CONSERVEZ CES INSTRUCTIONS À TITRE DE RÉFÉRENCE ULTÉRIEURE

Suivez les instructions d'assemblage en les lisant dans l'ordre numérique croissant.

Faites appel un électricien qualifié pour l'installation de ce luminaire.

Avant d'installer le luminaire, coupez le courant en déclenchant le disjoncteur ou en retirant le fusible dans la boîte à fusibles

Tous les branchements électriques doivent être conformes aux codes locaux et au Code national de l'électricité ou aux normes du Code canadien de l'électricité.

Utilisez des capuchons de connexion homologués ACN ou UL convenant à la taille, au type et au nombre de conducteurs.

Raccordez le fil de mise à la terre de la boîte de sortie de courant (vert ou en cuivre dénudé) au fil en cuivre dénudé du luminaire. Si la boîte de sortie de courant ne possède pas de fil de mise à la terre, raccordez le fil en cuivre dénudé du luminaire à la vis de mise à la terre verte de la traverse.

Temps d'assemblage approximatif : 20 minutes

Outils requis pour l'assemblage (non compris) : Tournevis plat, tournevis cruciforme, pince, ruban isolant et coupe-fils.

Outils utiles (non compris) : Outils à dénuder, échelle

## CONSERVA ESTAS INSTRUCCIONES PARA CONSULTAS FUTURAS

Sigue las instrucciones de ensamblaje según el orden numérico.

Contrata a un electricista calificado para instalar esta lámpara.

Antes de comenzar a instalar esta lámpara, corta la electricidad apagando el cortacircuitos o retirando el fusible en la caja correspondiente.

Todas las conexiones eléctricas tienen que cumplir con las normas locales y del Código Nacional de Electricidad (N.E.C., por sus siglas en inglés) o del Código Canadiense de Electricidad.

Usa conectores de cable con clasificación UL o CSA, apropiados para el calibre, tipo y cantidad de conductores.

Une el cable a tierra de la caja de conexiones (verde o cobre pelado) y el cable de cobre pelado de la lámpara. Si la caja de conexiones no tiene cable a tierra, conecta el cable de cobre pelado de la lámpara al tornillo verde a tierra en la barra transversal.

Tiempo aproximado de ensamblaje: 20 minutos

Herramientas necesarias para el ensamblaje (no incluidas): Destornillador de cabeza plana, destornillador Phillips, alicate, cinta de electricista y cortacables.

Herramientas útiles (no incluidas): Pelacables, escalera

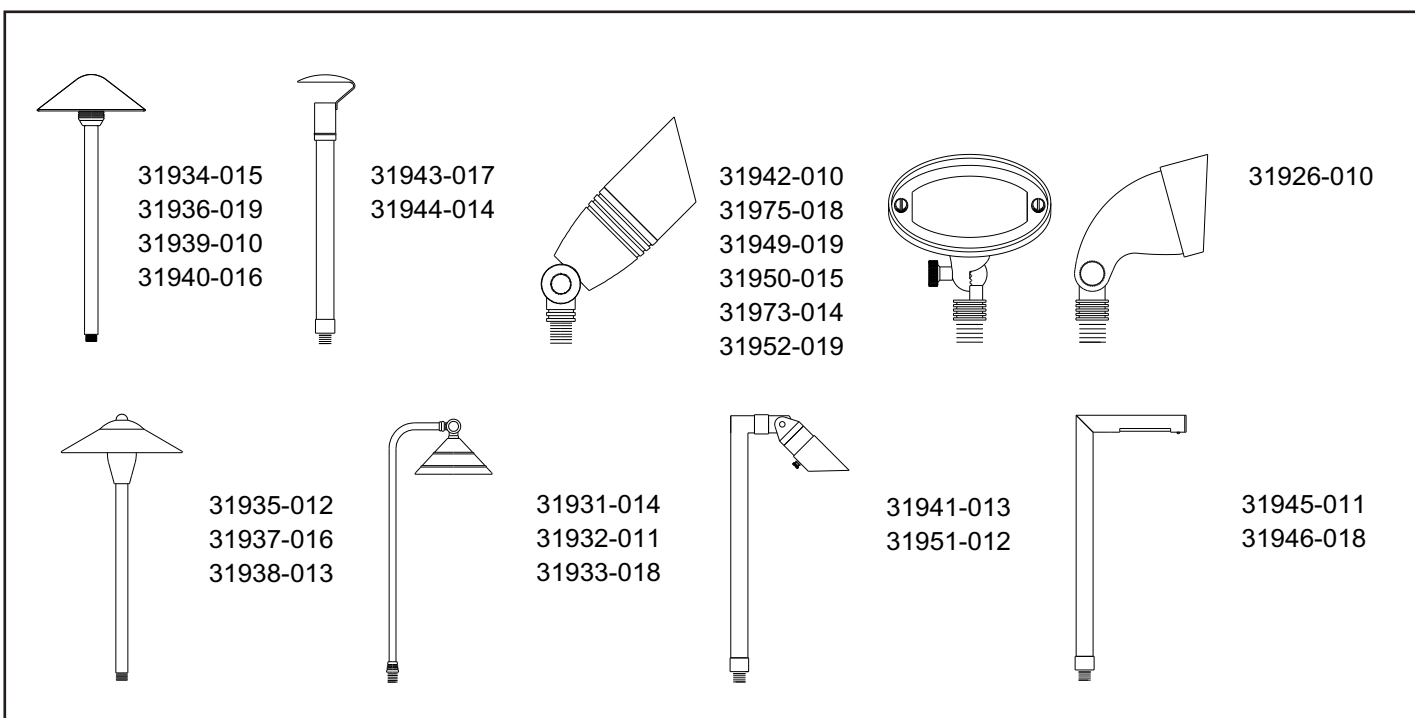

A:SPIKE  
 B:Main supply cable  
 C:Fixture Cable  
 D:Wire Nuts X2pcs(Not Included)

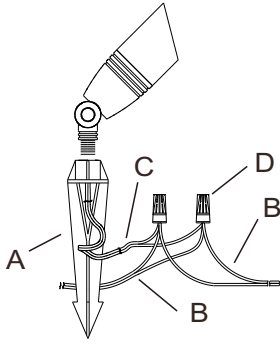

12V AC/DC  
 6W 40degree  
 Integrated led 2700K

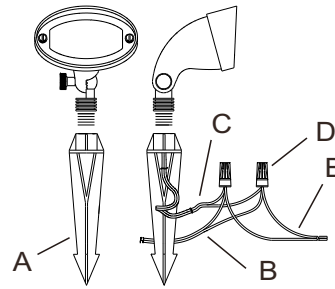

12V AC/DC  
 3W 120degree  
 Integrated led 2700K

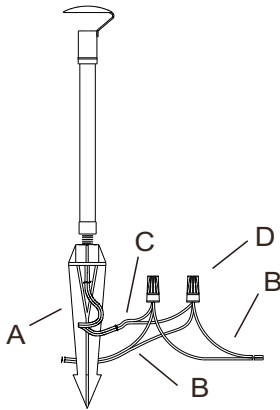

12V AC/DC  
 3W 60degree  
 Integrated led 2700K

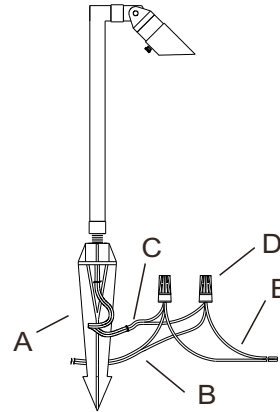

12V AC/DC  
 3W 40degree  
 Integrated led 2700K

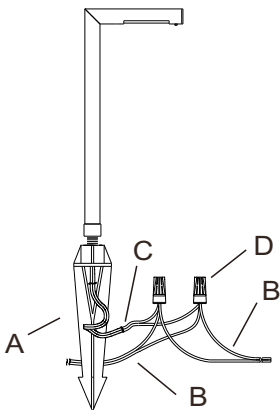

12V AC/DC  
 3W 120degree  
 Integrated led 2700K

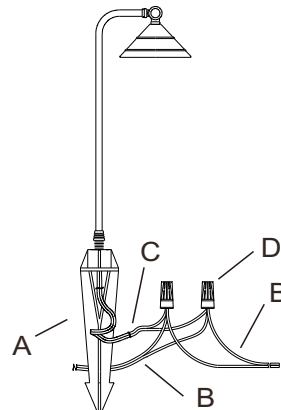

12V AC/DC  
 4W 180degree  
 Integrated led 2700K

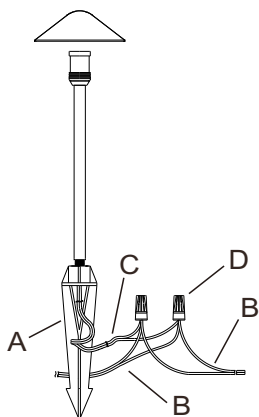

12V AC/DC  
 4W 180degree  
 Integrated led 2700K

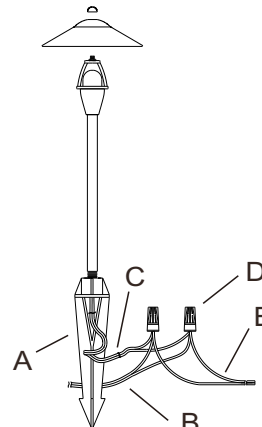

12V AC/DC  
 4W 180degree  
 Integrated led 2700K

**.WARNING-Risk of Electric shock:** This fixture is not to be installed within 10 feet (3M) of a pool, spa or fountain.  
 .This fixture is to be used only with a power unit (transformer) rated a maximum of 300 W (25 AMPS) 12 volts.  
 .Direct burial rated wire is to be buried less than 6" (152mm) beneath the surface of the ground.  
 .Wiring connections must be made with waterproof wire nuts (Not Included) or other equally suitable connector for the application. Do not exceed manufacturers' wiring combination specifications for size and quantity of conductors.  
 Follow the assembly instructions by reading the character progression.