

## 24061, NC PLATE: TE104B/TE134BLED

### PRODUCT DETAILS

No.	:	24061-018
Length	:	20"
Width	:	18"
Height	:	1.375"

### TECHNICAL DETAILS

Cut Hole Length	:	12.75"
Cut Hole Width	:	12.75"



### Options Available

ITEM NO.	FINISH	SHADE
24061-018		

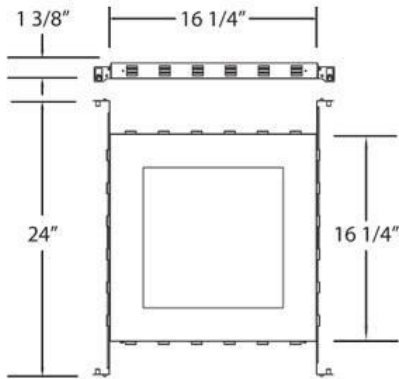

### PROJECT INFORMATION

Job Name:       Date:       Type:

Comments: