



WALL MOUNT
HID OUTDOOR
FLOOD LIGHT
LARGE SIZE
WML-400-HPS-MT



PROJECT	Canadalite.com
FIXTURE TYPE	
MODEL	
LAMP	
CONTACT/TELEPHONE	1(888)887-7038

Specifications

Description

Outdoor wall mounted large size HID flood light, CUL listed for wet location. Designed for easy installation with 400W High Pressure Sodium lamp for 120V application.

Lamp Wattage / Type

- Supplied with 400W clear mogul base, ED37 HPS.

Features

- Designed for commercial applications.
- Fast and easy mounting to reduce installation cost.
- Heat resistant borosilicate glass lens.
- Aluminum reflector diffuser provide effective light distribution.

Housing

- Die-cast Aluminum housing designed for maximum heat dissipation.
- Fully gasket housing to prevent water, dirt, and bugs from entering the optical compartment.
- Electrostatic powder finish in bronze and white.

Electrical

- 120/277/347V, 60Hz.
- Capable of starting from -30°C.

Dimensions & Ordering Guide

Model

WML-400-HPS-MT-BR
WML-400-HPS-MT-WH

Description

Bronze Housing
White Housing
• 400W multi-tap HPS large size energy saving flood light designed for outdoor wet location applications

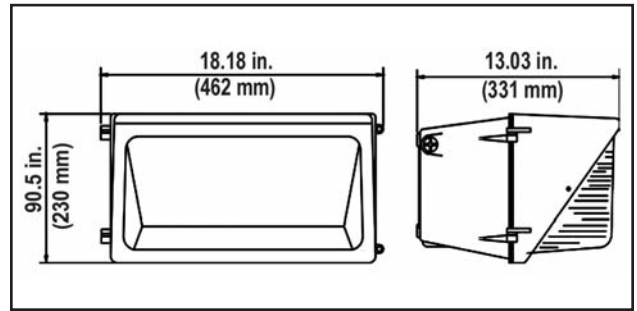

Listings



LITELINE CORPORATION

8 Abacus Road, Brampton, Ontario, Canada L6T 5B7
Tel: 416-996-1856 • Fax: 905-794-1990 / 1-888-738-9736
E-mail: sales@liteline.com • Website: liteline.com

Product specifications subject to change without notice.

WML-400-HPS-MT

**WALL MOUNT HID
OUTDOOR FLOOD LIGHT
LARGE SIZE**

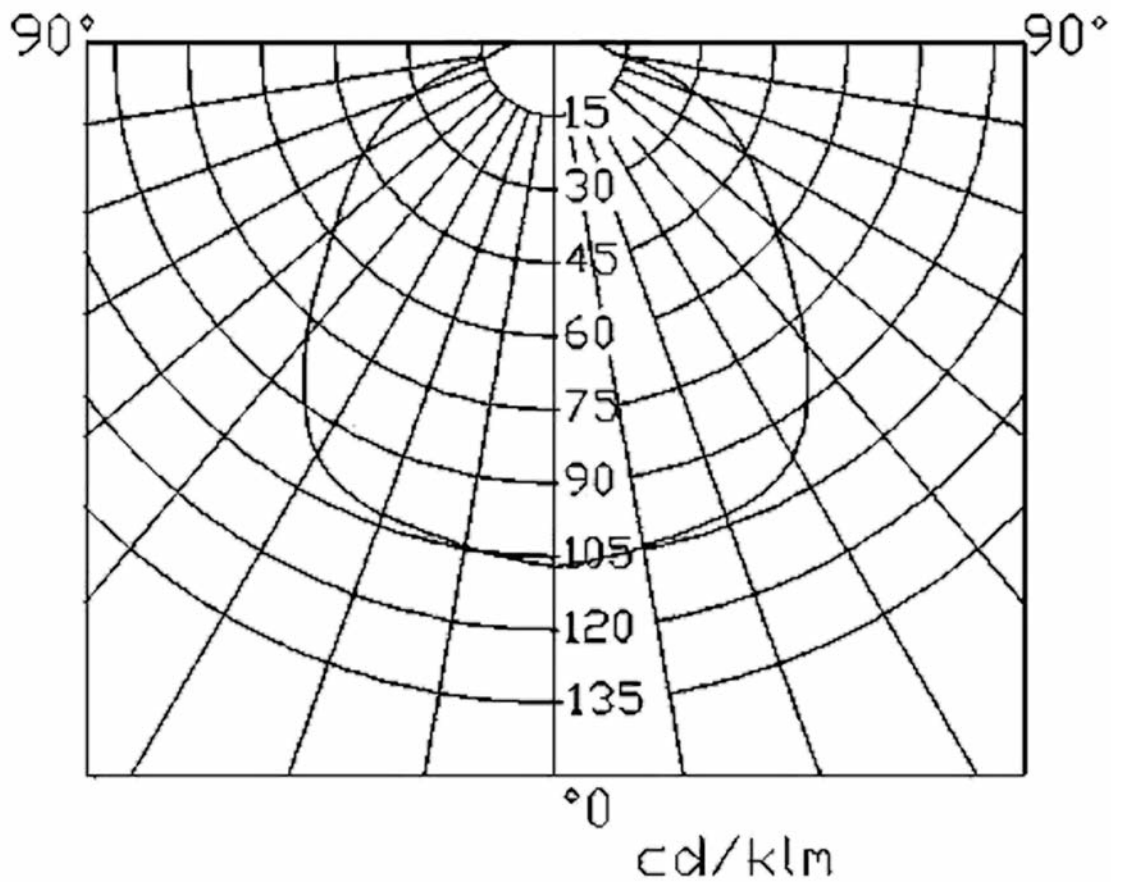

Listings



LITELINE CORPORATION

8 Abacus Road, Brampton, Ontario, Canada L6T 5B7
Tel: 416-996-1856 • Fax: 905-794-1990 / 1-888-738-9736
E-mail: sales@liteline.com • Website: liteline.com

Product specifications subject to change without notice.