



✉ 33 West Beaver Creek Road Richmond Hill
Ontario Canada L4B 1L8

☎ 800.660.5391

☎ 800.660.5390

✉ info@eurofase.com

🌐 www.eurofase.com

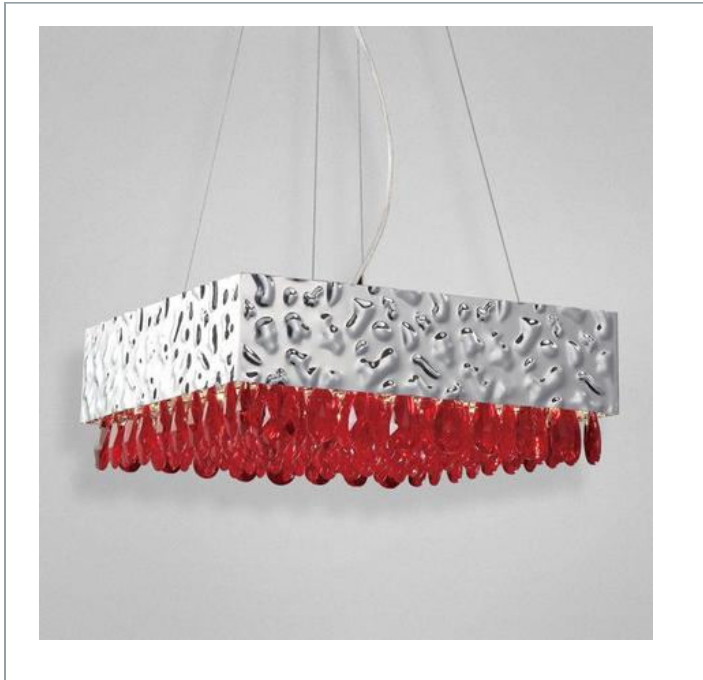

MARTELLATO , 12-LIGHT PENDANT

Product Specifications

Item No.:	19512-051
Height:	8.75"
Chain / Cord Length:	72"
Width:	23.5"
Length:	23.5"
Est. Shipping Weight:	24.20 lbs
No. of Bulbs:	12
Bulb Wattage:	40 watts
Bulb Type:	G9
Bulb Base:	G9
Bulb Voltage:	120 volts

Options Available

ITEM CODE	FINISH	SHADE
19512-037	chrome	pink
19512-020	chrome	smoke
19512-013	chrome	clear
19512-051	chrome	red
19512-044	chrome	amber

Embossed silver sheets compose the influential rectangular framework, providing a subtle texture and intricate depth. This impressive design is contrasted with a bed of crystal-cut droplets that sway translucently from the base, and scatter light in a daring prism of creativity.

Colour / Shades Available

FINISH	SHADE
chrome	pink
chrome	smoke
chrome	clear
chrome	red
chrome	amber

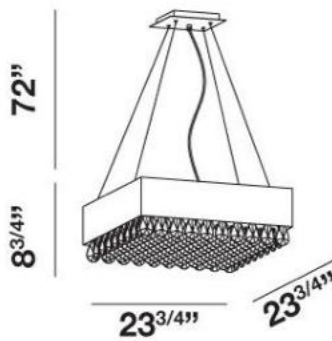

Project Information

Job Name: _____ Date: _____ Type: _____
 Comments: _____