



☒ 33 West Beaver Creek Road Richmond Hill  
 Ontario Canada L4B 1L8  
 ☎ 800.660.5391  
 ☎ 800.660.5390  
 ✉ info@eurofase.com  
 🌐 www.eurofase.com



## MARTELLATO , 12-LIGHT PENDANT

### Product Specifications





Item No.: 19512-013  
 Height: 8.75"  
 Chain / Cord Length: 72"  
 Width: 23.5"  
 Length: 23.5"  
 Est. Shipping Weight: 24.20 lbs  
 No. of Bulbs: 12  
 Bulb Wattage: 40 watts  
 Bulb Type: G9   
 Bulb Base: G9  
 Bulb Voltage: 120 volts

### Options Available

ITEM CODE	FINISH	SHADE
19512-037	chrome	pink
19512-020	chrome	smoke
19512-013	chrome	clear
19512-051	chrome	red
19512-044	chrome	amber

Embossed silver sheets compose the influential rectangular framework, providing a subtle texture and intricate depth. This impressive design is contrasted with a bed of crystal-cut droplets that sway translucently from the base, and scatter light in a daring prism of creativity.

### Colour / Shades Available

FINISH	SHADE
chrome	 pink
chrome	 smoke
chrome	 clear
chrome	 red
chrome	 amber

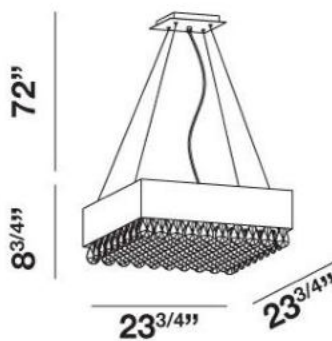

### Project Information

Job Name: \_\_\_\_\_ Date: \_\_\_\_\_ Type: \_\_\_\_\_  
 Comments: \_\_\_\_\_