



COSMO , 1-LIGHT WALL SCNCE







Product Specifications

| | |
|-----------------------|--|
| Collection: | Illuminations |
| Item No.: | 23203-068 |
| Extension: | 5.5" |
| Width: | 7" |
| Length: | 7" |
| Est. Shipping Weight: | 1.69 lbs |
| No. of Bulbs: | 1 Inc. |
| Bulb Wattage: | 60 watts |
| Bulb Type: | G9  |
| Bulb Base: | G9 |
| Bulb Voltage: | 120 volts |

Options Available

| ITEM CODE | FINISH | SHADE |
|-----------|--------|---------------|
| 23203-037 | chrome | clear |
| 23203-051 | chrome | frosted white |
| 23203-013 | chrome | amber |
| 23203-020 | chrome | red |
| 23203-044 | chrome | purple |
| 23203-068 | chrome | chrome |

Colour / Shades Available

| FINISH | SHADE |
|--------|---|
| chrome |  clear |
| chrome |  frosted white |
| chrome |  amber |
| chrome |  red |
| chrome |  purple |
| chrome |  chrome |

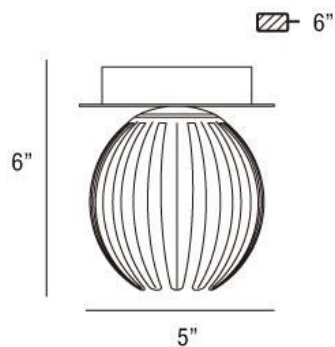

Project Information

Job Name: _____ Date: _____ Type: _____
 Comments: _____